

Product Information

HD1K-008..025GM / K

**Flow Switch
HD1K**



- High switching power
- Compact design

Characteristics

Mechanical flow switch, for fluid or gaseous media, with spring-supported piston and magnetic triggering of a reed switch. Robust construction in brass or stainless steel.

Technical data

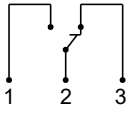
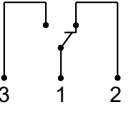
Switch	reed switch	
Nominal width	DN 8..25	
Process connection	female thread G 1/4..G 1 (further process connections available on request)	
Switching range	0.1..80 l/min	for details see table "Ranges"
Pressure loss	0.4..1.6 bar at Q _{max.}	
Q_{max.}	to 100 l/min	
Tolerance	±5 % of full scale value	
Pressure resistance	PN 200 bar optionally PN 500 bar	
Media temperature	-20..+120 °C with display Z -20..+70 °C optionally -20..+150 °C	
Ambient temperature	-20..+70 °C	
Media	water, oil (gases and aggressive media available on request)	
Wiring	changeover No. 0.213  optionally changeover No. 0.282  optionally red or red / green diode in the DIN 43650-A plug	
Switching voltage	max. 175 V DC / 120 V AC	
Switching current	Max. 0.25 A DC / 0.18 A AC	
Switching capacity	Max. 5 W / VA	
Protection class	2 - Safety insulation	
Ingress protection	IP 65	

Electrical connection	plug DIN 43650-A / ISO 4400 Optionally for round plug connector M12x1, 4-pole	
Materials medium-contact	<i>Brass construction:</i> CW614N nickelled, CW614N, 1.4310, hard ferrite, NBR	<i>Stainless steel construction:</i> 1.4571, 1.4404, 1.4310, hard ferrite PTFE-coated, FKM
Non-medium-contact materials	PA, CW614N, NBR	
Weight	see table "Dimensions and weights"	
Installation location	Standard: horizontal inwards flow from the left; other installation positions are possible; the installation position affects the switching point and range.	

Ranges

For switching ranges, the details in the table correspond to horizontal inwards flow and decreasing flow rate; for display ranges they correspond to horizontal inwards flow and increasing flow rate.

Standard type HD1K

Switching range l/min H ₂ O	Optionally Display range l/min H ₂ O	Q _{max.} recommended	Pressure loss bar at Q _{max.} H ₂ O
0.1 - 1.0	0.1 - 1.2	6	0.4
0.5 - 5.0	0.5 - 6.0	10	0.5
1.0 - 10.0	1.0 - 12.0	20	0.6
2.0 - 20.0	2.0 - 23.0	30	0.4
3.0 - 30.0	3.0 - 34.0	40	
4.0 - 40.0	4.0 - 45.0	60	0.8
6.0 - 60.0	6.0 - 65.0	80	1.4
20.0 - 80.0	20.0 - 85.0	100	1.6

Special ranges are available.

Product Information

HD1K-008..025GM / K

Dimensions and weights

	G	Types	SW	X	Weight kg
Brass	G 1/4	HD.K-008GM	40	15	1.4
	G 3/8	HD.K-010GM			
	G 1/2	HD.K-015GM		18	1.3
	G 3/4	HD.K-020GM			
	G 1	HD.K-025GM			
Stainless steel	G 1/4	HD.K-008GK	41	15	1.3
	G 3/8	HD.K-010GK			
	G 1/2	HD.K-015GK			
	G 3/4	HD.K-020GK		18	1.2
	G 1	HD.K-025GK			

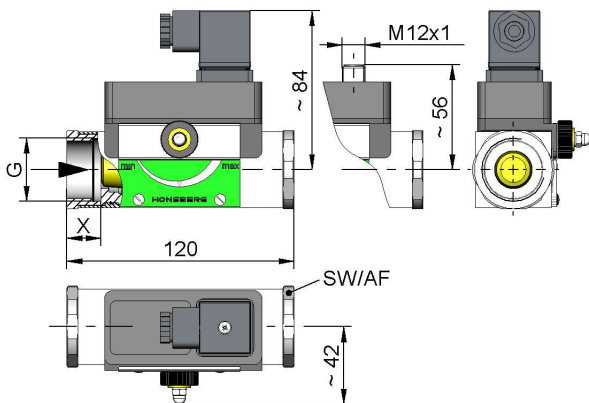

additional weights for options

additional switching head 0.10 kg Display O / Z 0.10 kg
 Display O1 / Z1 0.05 kg

Handling and operation

Note

- Include straight calming section of 5 x DN in inlet and outlet
- If the media are dirty, install a filter (use magnetic filter for ferritic components).
- It must be ensured that the values given for voltage, current, and power are not exceeded.
- When switch on, a load must be connected in series.
- The electrical details apply to ohmic loads. Capacitive, inductive and lamp loads must be operated using a protective circuit.

Adjustment

If it is necessary to set the switching value, the switching head can be adjusted by adjustment of a pinion. When the switching value is reached, the switching unit is fixed in place by a fastening bolt (SW 8).



Ordering code

HD 1. 2. 3. 4. 5. 6. 7.
 G

1. Construction		
1K	standard	
2. Display options		
-	no mechanical display	
O1-	with measurement display at side O1	
O-	with measurement display at side O	
Z1-	with frontal measurement display Z1	
Z-	with frontal measurement display Z	
3. Nominal width		
008	DN 8 - G 1/4	
010	DN 10 - G 3/8	
015	DN 15 - G 1/2	
020	DN 20 - G 3/4	
025	DN 25 - G 1	
4. Process connection		
G	female thread	
5. Connection material		
M	brass	
K	stainless steel	
6. HD1K - switching range H₂O for horizontal inwards flow		
001	0.1 - 1 l/min	●
005	0.5 - 5 l/min	●
010	1.0 - 10 l/min	●
020	2.0 - 20 l/min	●
030	3.0 - 30 l/min	●
040	4.0 - 40 l/min	●
060	6.0 - 60 l/min	●
080	20.0 - 80 l/min	●
7. Special switching head		
A	switching head ATEX A-H1.1 / A-H2.1 Please order the switching head for -use in addition.	

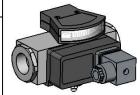

HD.KO1-

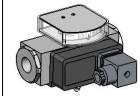

HD.KO-



HD.KZ1-

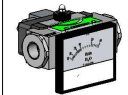

HD.KZ-

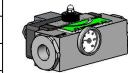

Temperature-
display



Options

- Signal lamp red or red / green in the plug DIN 43650-A
- Switch contact SPST change over 250 VAC, 0,35 A, 30 VA - increased hysteresis depending on switching value. Only available with fixed switch point.
- Switch contact SPST N.O. 250 V DC 1.5 A 50 W / 265 V AC 1.1 A 50 VA
- Temperature resistant up to 150 °C
- Reinforced piston (only if made of brass)
- Additional switching head
- Connection for round plug connector M12x1
- High pressure model PN 500 (only if made of brass)
- Adjustment scale with markings in l/min
- Temperature monitoring
- Damping for gas monitoring (only for standard version)
- Switching values for oil or gas
- Special values
- Temperature display 0..120 °C
- Switching head made of metal

Ordering information

- Specify direction of flow, medium, and switching range.
- For viscous media specify viscosity, temperature, and medium (e.g. ISO VG 68) (enquire about switching range).
- For gases, state pressure (relative or absolute), temperature

Product Information

HD1K-008..025GM / K

and medium (e.g. air) (request switching range).