

Operating manual

Precipitation detector

HD2013.3



Members of GHM GROUP:

GREISINGER

HONSBURG

Martens

DeltaOHM

VAL.CO

www.deltaohm.com

Keep for future reference.

TABLE OF CONTENTS

1	INTRODUCTION	3
2	TECHNICAL SPECIFICATIONS	4
3	INSTALLATION	6
	3.1 ELECTRICAL CONNECTIONS	6
4	CONFIGURATION AND MEASUREMENT	9
5	PROPRIETARY PROTOCOL	10
6	MODBUS-RTU PROTOCOL	17
7	MAINTENANCE	21
8	SAFETY INSTRUCTIONS	21
9	ORDERING CODES	22

1 INTRODUCTION

HD2013.3 is a precipitation detector based on the capacitive principle. The capacity value of the sensitive element changes according to the surface dampened by raindrops.

An integrated heater keeps the detector dry, evaporates water and prevents false signals caused by fog or dew. The heater also activates at low temperatures, melting the snow and allowing detecting snow precipitations by using an ambient temperature sensor.

The instrument external circular dome acts as a windshield for the sensor, preventing false indications.

An auto-calibration algorithm compensates for variations in the response due to the dirt that can accumulate on the sensitive surface.

The instrument has a digital RS485 output with MODBUS-RTU or proprietary protocol, a 0/4...20 mA (0...10 V **on request when ordering**) analog output and a voltage-free contact output. The contact output is activated when the sensor detects a precipitation in progress.

The detector has IP68 protection degree.

Supplied with fixing bracket for Ø 30...50 mm mast.

Optional bird spikes (to be requested when ordering the detector) can be mounted.

2 TECHNICAL SPECIFICATIONS

Precipitation sensor	
Type	Capacitive, with integrated heater
Dimensions	6.6 cm ²
Angle	30°
Sensitive area	0.05 cm ² min.
Temperature sensor	NTC 10KΩ @ 25 °C
Measuring range	
Precipitation detection	ON / OFF (precipitation in progress / no precipitation) Percentage of dry sensitive surface of the sensor
Temperature	-40...+60 °C
Resolution	
Precipitation detection	Configurable 1 % (default) or 0.1 % of dry sensitive surface of the sensor
Temperature	0.1 °C
Output	RS485 not isolated, with MODBUS-RTU or proprietary protocol Analog 0/4...20 mA ($R_{Lmax} = 500 \Omega$) or on request 0...10 V ($R_{Lmin} = 10 k\Omega$) Voltage-free normally open contact max. 200 mA @ 30 Vdc resistive load
Power supply	12...30 Vdc
Consumption	With heating OFF: 18 mA @24 Vdc With heating ON: 230 mA max @24 Vdc The indicated consumption does not include the consumption due to the analog output
Connection	8-pole circular connector
Operating conditions	-40...+60 °C / 0...100 %RH
Storage temperature	-40...+60 °C
Dimensions	Ø 70 x 70 mm (only the instrument without mounting bracket)
Weight	450 g approx.
Protection degree	IP 68
Housing material	Technopolymer ASA

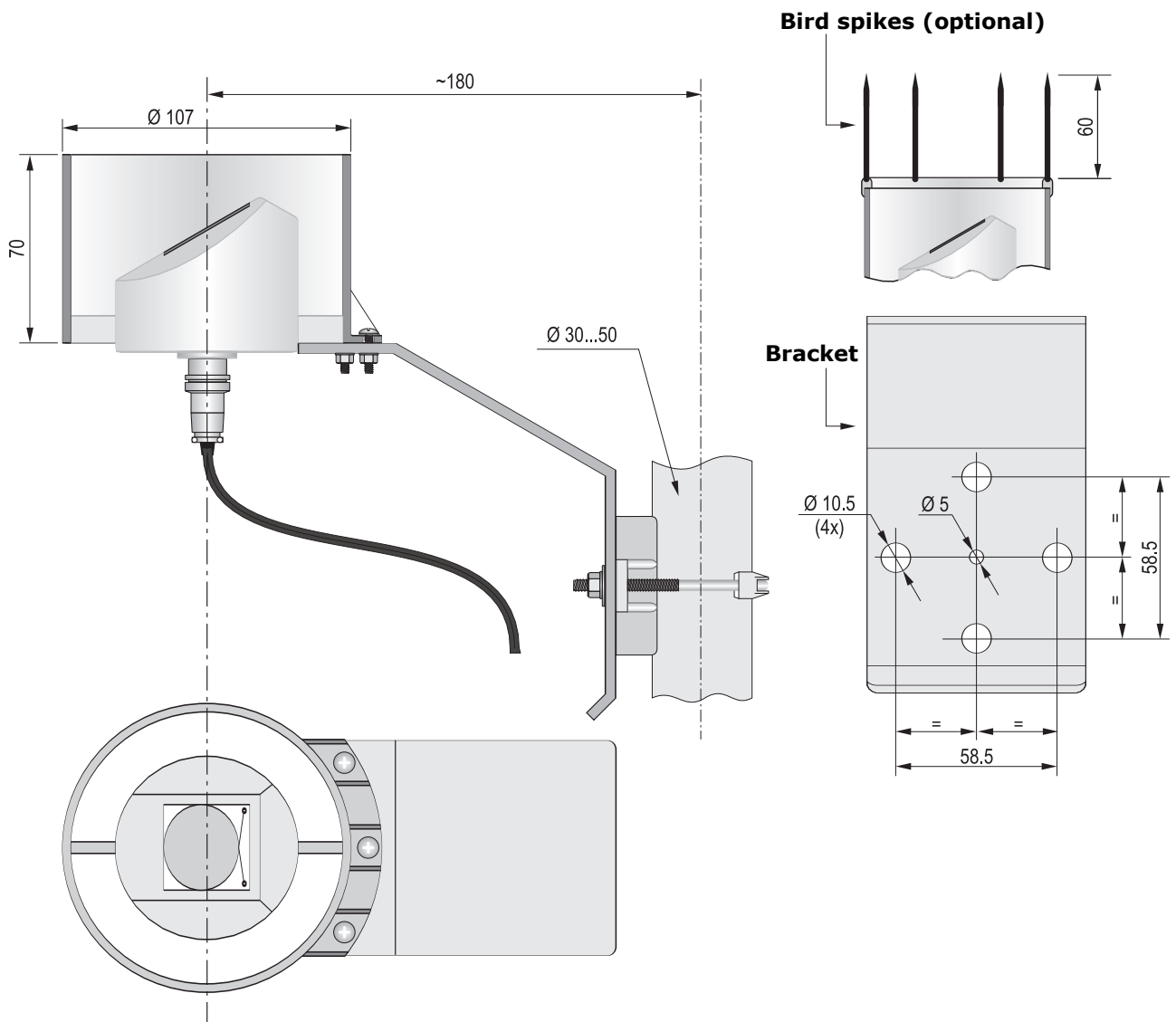

Fig. 2.1: dimensions (mm)

3 INSTALLATION

Use the supplied accessories to mount the instrument. The bracket can be fixed to a \varnothing 30...50 mm mast, both vertical and horizontal, thanks to the double drilling on the bracket.

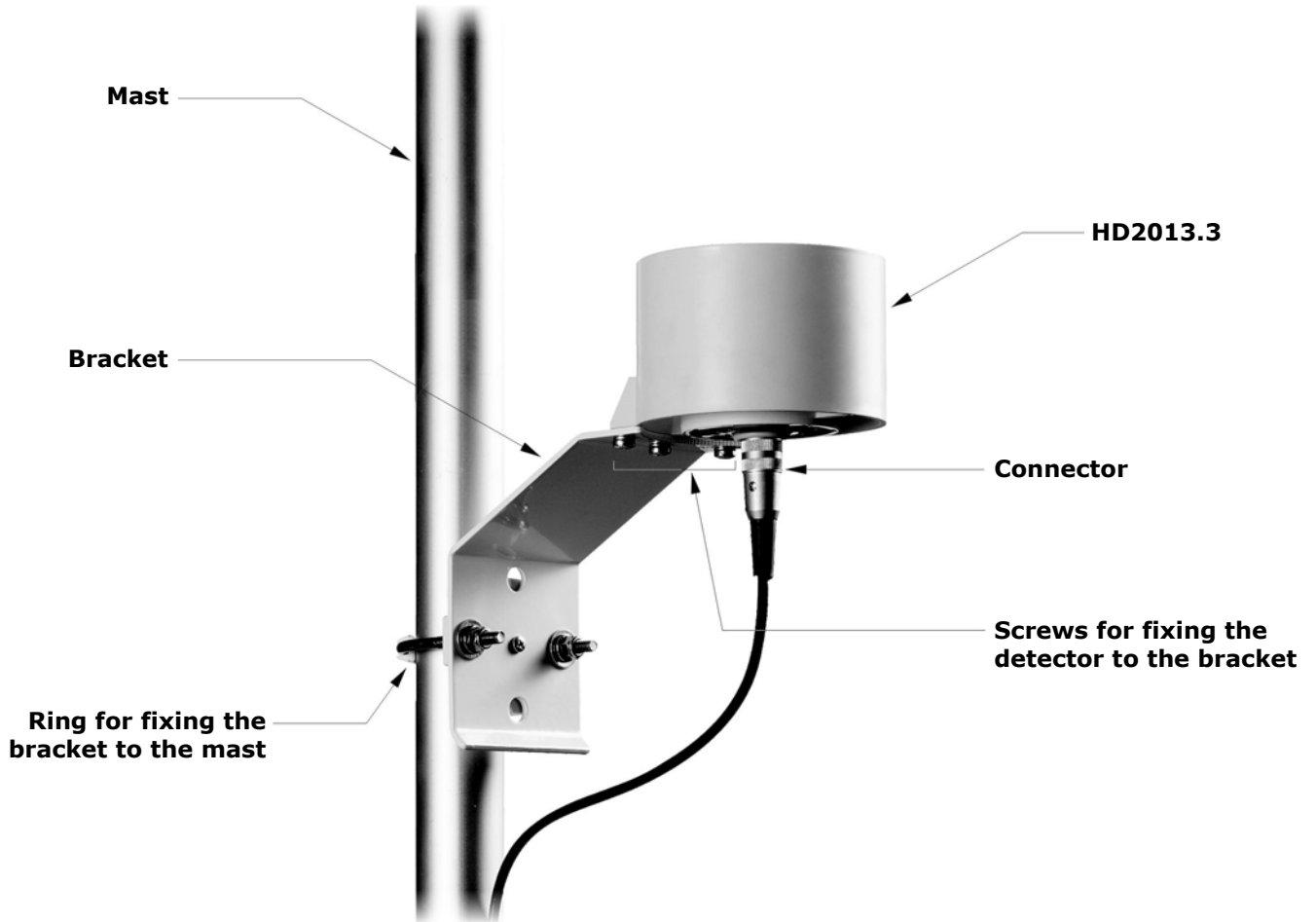

Fig. 3.1: installation on vertical mast

Place the detector far from buildings, trees, etc..., taking care that the space above is free from any object that could obstruct the detection of the precipitation. Keep the sensor clean.

3.1 ELECTRICAL CONNECTIONS

The instrument has a 8-pole circular connector and uses the **CP2013.2... optional** cables, with 8-pole connector on one side and open wires on the other side.

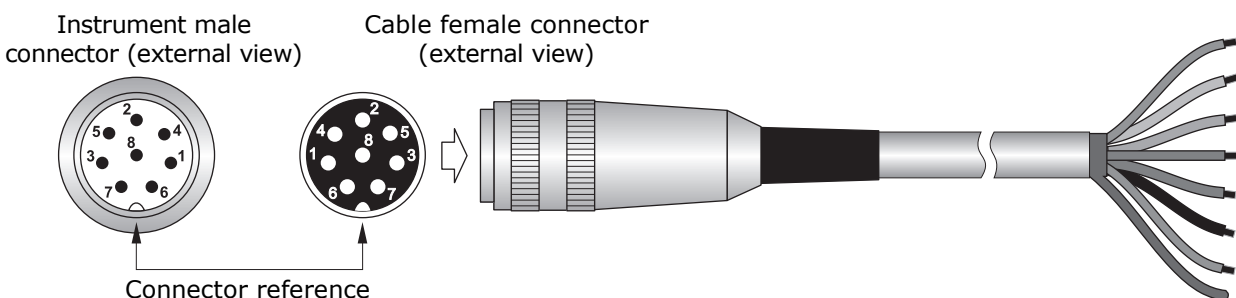

Fig. 3.2: connectors pinout

Connector	Function	Wire color CP2013.2... cable
1	Voltage-free contact	Green
2	Power supply positive (+Vdc)	Red
3	RS485 B/+	White
4	Voltage-free contact	Blue
5	RS485 A/-	Brown
6	Analog output positive	Yellow
7	Power supply negative (GND)	Grey
8	Serial ground	Black

To ensure a good noise immunity, it is recommended to connect the cable shield to ground (GND).

RS485 connection:

By default, the instrument has MODBUS address **1** and communication parameters 19200, 8E1. Different parameters can be set using the proprietary protocol or the MODBUS-RTU protocol.

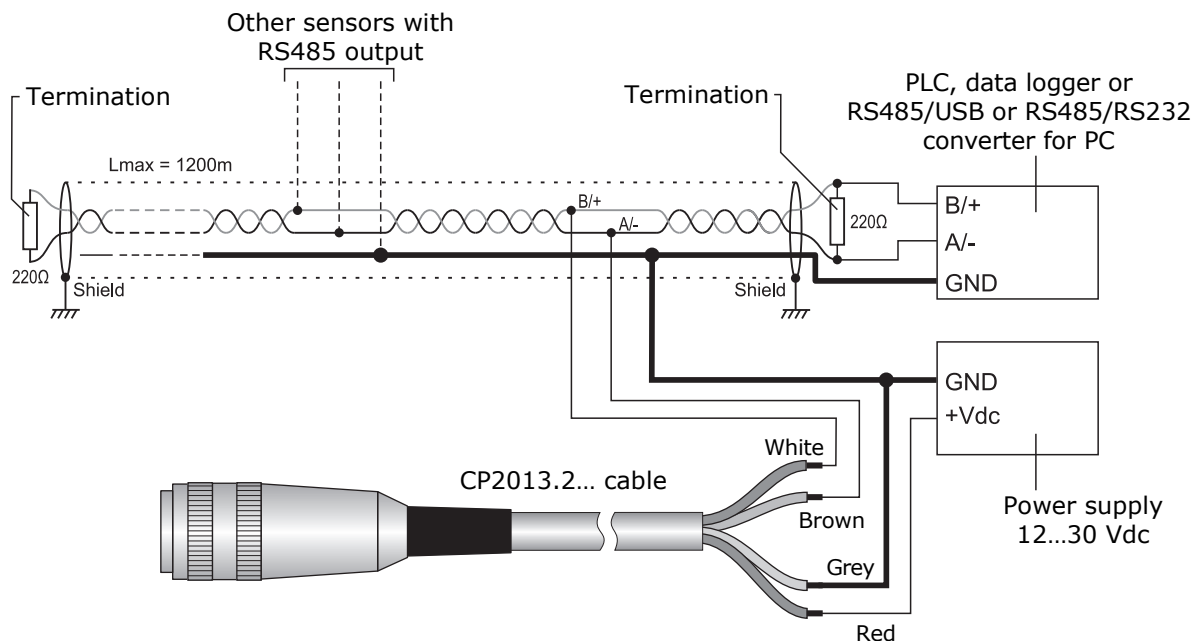

Fig. 3.3: RS485 connection

Current analog output:

By default, the current analog output is 4...20 mA, with:

- 4 mA = sensor sensitive surface completely wet
- 20 mA = sensor sensitive surface completely dry

With the commands of the proprietary protocol it is possible to set the range 0...20 mA for the output and reverse the direction of the output, so that when the sensor sensitive surface is completely wet the output is 20 mA.

In case of measurement error, the output goes to 22 mA.

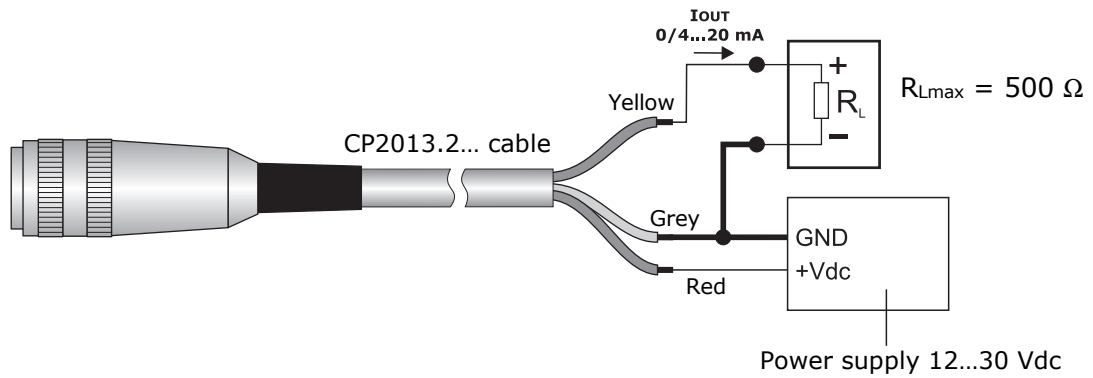

Fig. 3.4: current analog output connection

Voltage analog output (optional):

By default, the voltage analog output is 0...10 V, with:

0 V = sensor sensitive surface completely wet

10 V = sensor sensitive surface completely dry

With the commands of the proprietary protocol it is possible to set the range 2...10 V for the output and reverse the direction of the output, so that when the sensor sensitive surface is completely wet the output is 10 V.

In case of measurement error, the output goes to 11 V.

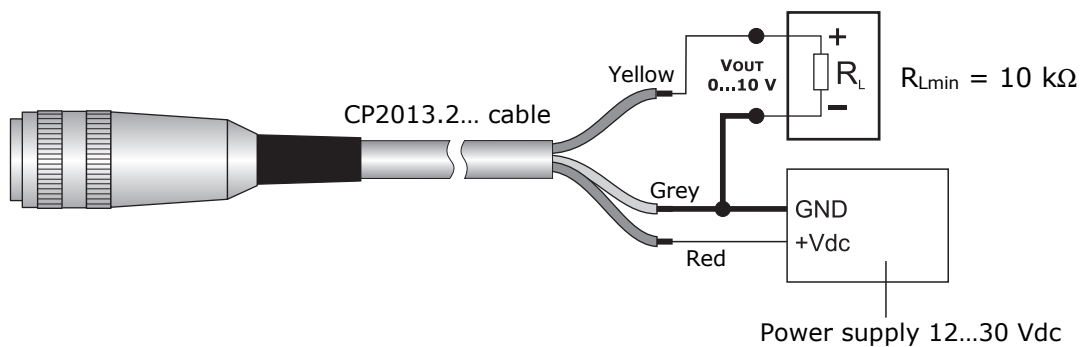

Fig. 3.5: voltage analog output connection

Contact output:

There is a normally open voltage-free contact between pins 1 and 4 of the connector (green and blue wires of the optional CP2013.2... cable). The contact closes when the sensor detects a precipitation in progress.

4 CONFIGURATION AND MEASUREMENT

The configuration of the instrument and the reading of the measurements can be done via the RS485 serial output, both with the proprietary protocol and with the MODBUS-RTU protocol.

In the first 10 seconds after the instrument power on, it is always active the proprietary protocol. After 10 seconds from power on, the operating protocol is activated, which by default is the MODBUS-RTU protocol.

It is possible to keep the proprietary protocol active even after 10 seconds from power on by sending, before the 10 seconds expire, the command @ of the proprietary protocol. The proprietary protocol can be set as operating protocol by means of the CP0 command.

The commands of the proprietary protocol and the registers of the MODBUS-RTU protocol are described in detail in the following chapters.

Precipitation measurement:

To determine if a precipitation is in progress, the instrument detects the percentage of dry sensitive surface of the sensor:

100% = sensitive surface of the sensor completely dry

0% = sensitive surface of the sensor completely wet

When the percentage of dry sensitive surface of the sensor falls below a configurable threshold value (default 95%), the instrument indicates that a precipitation is in progress. The threshold value can be modified with the command CRTnn of the proprietary protocol or by using the MODBUS holding register with address 5.

The indication of precipitation in progress ceases when the percentage of dry sensitive surface of the sensor rises above the threshold plus a configurable hysteresis value (default 2%) and after a configurable delay time (default 2 minutes).

The resolution with which the percentage of dry sensitive surface of the sensor is detected is 1% by default. The resolution can be set to 0.1% with the command CRLRn of the proprietary protocol or by using the MODBUS holding register with address 16.

The instrument discriminates between rainfall and snowfall based on the measured ambient temperature. If the ambient temperature is lower than a configurable reference temperature (default 2 °C), the precipitation is considered snowy.

The detection sensitivity can be adjusted with the command DRSn of the proprietary protocol or by using the MODBUS holding register with address 20.

Automatic calibration of the precipitation sensor:

The instrument can be set so as the precipitation sensor calibration is automatically performed at regular intervals; this allows compensating for any drift of the sensor due to temperature changes, aging and dirt deposited on the sensitive surface.

The correction applied by each automatic calibration is limited to a maximum value (configurable), so as to avoid erroneous calibrations when the detected value differs too much from the estimated value.

By default, the automatic calibration is enabled, with 30 minutes interval and 0.1% maximum correction. In order to change the automatic calibration settings, see the chapters on the proprietary protocol and MODBUS-RTU protocol.

5 PROPRIETARY PROTOCOL

To use the proprietary protocol, it is necessary to connect the instrument to the PC via a RS485/USB (e.g. RS51K) or RS485/RS232 converter and use a standard serial communication program. In the serial communication program, set the COM port number to which the instrument is connected and the communication parameters as follows:

- If the MODBUS-RTU protocol is set as the operating protocol in the instrument (default), set the Baud Rate 57600 and the parameters 8N2 in the serial communication program, then power cycle the instrument and send the command @ within 10 seconds from the instrument power on.
- If the proprietary protocol is already set as the operating protocol in the instrument, it is possible to operate with Baud Rate 57600 and parameters 8N2 by sending the command @ within 10 seconds from the instrument power on, or you can let the 10 seconds pass without sending the command @ and operate with the communication parameters set in the instrument (default 19200, 8E1).

To change the instrument configuration, the serial command **CAL USER ON** must be sent first (the instrument replies with USER CAL MODE ON). The command CAL USER ON is automatically disabled after a few minutes of inactivity. If the settings should be only read, the command CAL USER ON is not required.

Below is the list of the serial commands.

Instrument information:

Command	Reply	Description
G0	<i>Model</i>	Instrument model
G1	<i>&Revision </i>	Instrument hardware revision
G2	SN=nnnnnnnn	Instrument serial number
G3	Firm.Ver.=x.y	Instrument firmware revision
G4	Firm.Date=yyyy/mm/dd	Date of firmware revision
GC	Fact.Calib.Date= yyyy/mm/dd	Date of factory calibration

Protocol:

Command	Reply	Description
@	&	Keeps the proprietary protocol operational even after 10 seconds from instrument power on. It must be sent within 10 seconds from instrument power on.
CPn	&	Sets the operating protocol: <ul style="list-style-type: none"> ▪ Proprietary if n=0 ▪ MODBUS-RTU if n=1 <i>Default</i> : MODBUS-RTU (n=1)
RP	& n	Reads the operating protocol set in the instrument.
SM	&	Activates the MODBUS-RTU protocol immediately.
CMA n	&	Sets the instrument address for the MODBUS-RTU protocol to n. The address should range within 1 and 247. <i>Default</i> : 1
RMA	& n	Reads the instrument address for the MODBUS-RTU protocol.

Note: after sending the CP1 command, the instrument remains with the proprietary protocol. Send the command SM to activate the MODBUS-RTU protocol immediately, or power cycle the

instrument.

RS485 communication parameters:

Command	Reply	Description
CMBn	&	Sets the Baud Rate: <ul style="list-style-type: none"> ▪ 1200 if n=0 ▪ 2400 if n=1 ▪ 4800 if n=2 ▪ 9600 if n=3 ▪ 19200 if n=4 ▪ 38400 if n=5 ▪ 57600 if n=6 ▪ 115200 if n=7 <i>Default</i> : 19200 (n=4)
RMB	& n	Reads Baud Rate setting
CMpn	&	Sets parity and stop bits: <ul style="list-style-type: none"> ▪ 8N1 if n=0 [No parity, 1 stop bit] ▪ 8N2 if n=1 [No parity, 2 stop bits] ▪ 8E1 if n=2 [Even parity, 1 stop bit] ▪ 8E2 if n=3 [Even parity, 2 stop bits] ▪ 8O1 if n=4 [Odd parity, 1 stop bit] ▪ 8O2 if n=5 [Odd parity, 2 stop bits] The number of data bits is fixed to 8. <i>Default</i> : 8E1 (n=2)
RMP	& n	Reads the setting of parity and stop bits.
CMWn	&	Sets waiting time after transmission with MODBUS-RTU protocol: <ul style="list-style-type: none"> ▪ Immediate reception if n=0 (violates protocol) ▪ Waiting 3.5 characters if n=1 (respects protocol) <i>Default</i> : Immediate reception (n=0)
RMW	& n	Reads the setting of waiting time after transmission with MODBUS-RTU protocol.

Precipitation detection settings:

Command	Reply	Description
CRLRn	&	Sets the resolution with which the percentage of dry sensitive surface of the sensor is detected: <ul style="list-style-type: none"> ▪ 1% if n=0 ▪ 0.1% if n=1 <i>Default</i> : 1% (n=0)
RRLR	& n	Reads the resolution with which the percentage of dry sensitive surface of the sensor is detected.
CRTn	&	Sets the precipitation detection threshold to n value, where n is the percentage of dry sensitive surface of the sensor below which the instrument indicates that a precipitation is in progress. If the 0.1% resolution is set, the value must be expressed in tenths (for example, write 970 to indicate 97.0%). <i>Default</i> : 97 (=97% with 1% default resolution)
RRT	& n	Reads the setting of the precipitation detection threshold.

Command	Reply	Description
CRHn	&	Sets the hysteresis of the precipitation detection threshold to n value. The value should range within 0 and 20%. If the 0.1% resolution is set, the value must be expressed in tenths (for example, write 10 to indicate 1.0%). <i>Default</i> : 1 (=1% with 1% default resolution)
RRH	& n	Reads the setting of the hysteresis of the precipitation detection threshold.
CSTn	&	Sets the reference temperature to discriminate between rainfall and snowfall to n value expressed in tenths of °C. The value should range within -50 (= -5.0 °C) and 50 (= +5.0 °C). <i>Default</i> : 20 (= +2.0 °C)
RST	& n	Reads the setting of the reference temperature to discriminate between rainfall and snowfall.
CSHn	&	Sets the hysteresis of the reference temperature to discriminate between rainfall and snowfall to n value expressed in tenths of °C. The value should range within -5 (= -0.5 °C) and 5 (= +0.5 °C). <i>Default</i> : 5 (= +0.5 °C)
RSH	& n	Reads the setting of the hysteresis of the reference temperature to discriminate between rainfall and snowfall.
CRADn	&	Sets the delay in indicating the beginning of a precipitation, both rainy and snowy, to n seconds (0...32767 s). The indication of precipitation in progress is generated only if the precipitation lasts longer than the set time. <i>Default</i> : 0
RRAD	& n	Reads the setting of the delay in indicating the beginning a precipitation.
CRABn	&	Sets the delay in indicating the end of a precipitation, both rainy and snowy, to n seconds (0...32767 s). The indication of precipitation in progress ceases only after the set time has elapsed from the end of the precipitation. <i>Default</i> : 120
RRAB	& n	Reads the setting of the delay in indicating the end of a precipitation.
CTADn	&	Sets the delay in indicating the transition from rainfall to snowfall, when the temperature drops below the reference temperature, to n seconds (0...32767 s). <i>Default</i> : 0
RTAD	& n	Reads the setting of the delay in indicating the transition from rainfall to snowfall, when the temperature drops below the reference temperature.

Command	Reply	Description
CTABn	&	Sets the delay in indicating the transition from snowfall to rainfall, when the temperature rises above the reference temperature plus the hysteresis, to n seconds (0...32767 s). <i>Default: 0</i>
RTAB	& n	Reads the setting of the delay in indicating the transition from snowfall to rainfall, when the temperature rises above the reference temperature plus the hysteresis.
DRSn	&	Sets the sensitivity of the precipitation detection to n value (10...1000). The greater the n value, the greater the sensitivity. <i>Default : 100</i>
GRS	& n	Reads the setting of the sensitivity of the precipitation detection.

Contact output:

Command	Reply	Description
CRSn	&	Sets the contact output activation mode: <ul style="list-style-type: none"> ▪ Output disabled if n=0 ▪ Output activated in case of rainfall if n=1 ▪ Output activated in case of snowfall if n=2 <i>Note: the precipitation is considered a rainfall if the measured temperature is higher than the reference temperature, and a snowfall if the measured temperature is lower than the reference temperature.</i> <i>Default : Output activated in case of rainfall (n=1)</i>
RRS	& n	Reads the setting of the contact output activation mode.

Analog output:

Command	Reply	Description
CAOE	&	Adds the offset to the analog output: 4...20 mA or 2...10 V.
CAOD	&	Remove the offset from the analog output: 0...20 mA or 0...10 V.
CAOR	& n	Reads the setting of the offset for the analog output: <ul style="list-style-type: none"> ▪ Without offset if n=0 (<i>default for voltage output</i>) ▪ With offset if n=1 (<i>default for current output</i>)
CASE	&	Sets the following correspondence for the analog output: 4 mA / 0 V ⇒ 100% of dry sensitive surface 20 mA / 10 V ⇒ 0% of dry sensitive surface
CASD	&	Sets the following correspondence for the analog output: 4 mA / 0 V ⇒ 0% of dry sensitive surface 20 mA / 10 V ⇒ 100% of dry sensitive surface
CASR	& n	Reads the setting of the correspondence between analog output and percentage of dry sensitive surface: <ul style="list-style-type: none"> ▪ 4...20 mA / 0...10 V ⇒ 0...100% if n=0 (<i>default</i>) ▪ 4...20 mA / 0...10 V ⇒ 100...0% if n=1

Units of measurement:

Command	Reply	Description
TTn	&	Sets the temperature unit of measurement: <ul style="list-style-type: none"> ▪ °C if n=0 ▪ °F if n=1 <i>Default</i> : °C (n=0)
HH	& n	Reads the setting of the temperature unit of measurement.

Reading of the measurement information:

Command	Reply	Description
S0	&	Disable the sending of the measurement information.
S1	&	Enable the sending of the measurement information at regular intervals. To set the sending interval, use the command MT. For the meaning of the information sent by the instrument, see the command S2.
S2	& RAIN_RAW RAIN_LEVEL RAIN_STATUS RAIN_VALIDITY PRECIPITATION_TYPE AMB_TEMP VOLTAGE HEATER_TEMP MICRO_TEMP HEATER_MODE HEATER_PERCENTAGE	Prints the list of the measurement information sent by the instrument: RAIN_RAW = number of 12-bit ADC counts, proportional to the percentage of dry sensitive surface of the sensor RAIN_LEVEL = percentage of dry sensitive surface of the sensor RAIN_STATUS = indication of no precipitation (0) or precipitation in progress (1) RAIN_VALIDITY = validity of the precipitation indication (0=no, 1=yes) PRECIPITATION_TYPE = indication of the type of precipitation (0=rainfall, 1=snowfall) AMB_TEMP = ambient temperature VOLTAGE = power supply voltage HEATER_TEMP = heater temperature MICRO_TEMP = internal board temperature HEATER_MODE = heating operating mode HEATER_PERCENTAGE = percentage of heating power used
MTn	&	Sets the interval for sending the measurement information to n seconds (1...30 s). <i>Default</i> : 1
NT	& n	Reads the setting of the interval for sending the measurement information.

Heating:

Command	Reply	Description
CHMn	&	Sets the heating operating mode: <ul style="list-style-type: none"> ▪ Manual if n=0 ▪ Always on if n=1 ▪ Always off if n=2 ▪ Automatic if n=3 If the manual mode is set, the heating power set with the command CHP is used. <i>Default</i> : Automatic (n=3)
RHM	& n	Reads the setting of the heating operating mode.
CHPn	&	Sets the heating power for the manual operating mode to n value, as a percentage of the maximum power (0...100%) <i>Default</i> : 50 (=50% of the maximum power)
RHP	& n	Reads the setting of the heating power for the manual operating mode.

Advanced functions:

Command	Reply	Description
DFLT	&	Restores the factory configuration.
CU4	&	Calibrates the instrument. Send the command only if the sensor sensitive surface is completely dry.
CRBSn	&	Enable/disable the precipitation sensor automatic calibration at regular intervals: <ul style="list-style-type: none"> ▪ Disable if n=0 ▪ Enable if n=1 <i>Default</i> : Automatic calibration enabled
RRBS	& n	Reads the enabling status of the precipitation sensor automatic calibration.
CRBTn	&	Sets the time interval between two consecutive precipitation sensor automatic calibrations to n seconds (300...64800 s). <i>Default</i> : 1200 (=20 minutes)
RRBT	& n	Reads the setting of the time interval between two consecutive precipitation sensor automatic calibrations.
CRBMCn	&	Sets the maximum correction that can be applied by each precipitation sensor automatic calibration to n value expressed in tenths of %. The value should range within 1 (=0.1%) and 200 (=20.0%). <i>Default</i> : 4 (=0.4%)
RRBMC	& n	Reads the maximum correction that can be applied by each precipitation sensor automatic calibration.

Command	Reply	Description
CHDTn	&n	<p>Sets the temperature difference (ΔT) that is maintained between the sensor heated base, in the automatic heating operating mode, and the environment to n value expressed in tenths of °C.</p> <p><i>Note:</i> the greater the ΔT, the greater the drying speed of the sensor and the greater the detection of the end of precipitation; on the other hand, the greater the possibility that a very light precipitation is not detected or causes an oscillation in indicating the presence/absence of precipitation. The ΔT setting is therefore a compromise between opposite needs. If the difference ΔT is too low, condensation can form on the sensor surface, which can be detected as precipitation.</p> <p><i>Default:</i> 250 (=25.0 °C)</p>
RHDT	&n	<p>Reads the setting of the temperature difference (ΔT) that is maintained between the sensor heated base and the environment.</p>
GRC	&x y	<p>Reads the number of reboots (x) and watchdog timeouts (y) that occurred.</p>

6 MODBUS-RTU PROTOCOL

By default, the instrument has MODBUS address **1** and communication parameters 19200, 8E1. The address and the communication parameters can be changed by using the appropriate serial commands of the proprietary protocol or, alternatively, directly with MODBUS commands by changing the value of the Holding Registers described later.

The MODBUS-RTU protocol, if set as the operating protocol (default), is active after 10 seconds from the instrument power on.

In order to change the instrument configuration using the MODBUS-RTU protocol, the value 1 must be written first in the *Coil* number with address 1.

Below is the list of registers.

Discrete inputs:

Address	Description	Format
0	Indication of no precipitation (0) or precipitation in progress (1).	Bit
1	Validity of the precipitation indication: 0=no, 1=yes.	Bit
2	Indication of the type of precipitation: 0=rainfall, 1=snowfall.	Bit

Input Registers:

Address	Description	Format
0	Instrument model identification.	16-bit Integer
1	Instrument hardware revision.	16-bit Integer
2,3	Instrument serial number. (*)	16-bit Integer
4	Instrument firmware revision. The most significant byte indicates the major revision; the less significant byte indicates the minor revision.	16-bit Integer
5	Number of reboots that occurred.	16-bit Integer
6	Number of watchdog timeouts that occurred.	16-bit Integer
7	Power supply voltage in Volt (x10).	16-bit Integer
8	Internal board temperature (x10).	16-bit Integer
9	Number of 12-bit ADC counts, proportional to the percentage of dry sensitive surface of the sensor.	16-bit Integer
10	Percentage of dry sensitive surface of the sensor (x10 if the resolution is 0.1%).	16-bit Integer
11	Number of MODBUS communication error.	16-bit Integer
12	Ambient temperature (x10).	16-bit Integer
13	Heater temperature (x10).	16-bit Integer
14	Percentage of heating power used.	16-bit Integer
15	Indication of precipitation absent/in progress and type of precipitation: 0=no precipitation 1=rainfall 2=snowfall	16-bit Integer

(*) The Instrument serial number has 8 digits. Two consecutive registers must be accessed to read the number. The register with lower address contains the most significant 4 digits.

Coils:

Address	Description	Format
0	Set 1 to restore the factory configuration. Bit zeroing is automatic.	Bit
1	Enable configuration change: 0=no (default), 1=yes. The changes to <i>Coils</i> and <i>Holding Registers</i> will be accepted only if this register is set to 1.	Bit
2	Sets waiting time after transmission with MODBUS-RTU protocol: 0=immediate reception (default); 1=waiting 3.5 characters.	Bit
3	Set 1 to calibrate the instrument. Bit zeroing is automatic. Set 1 only if the sensor sensitive surface is completely dry.	Bit

Holding Registers:

Address	Description	Format
0	RS485 Baud Rate: 0=1200; 1=2400; 2=4800; 3=9600; 4=19200 (default); 5=38400; 6=57600; 7=115200.	16-bit Integer
1	RS485 parity and stop bits: 0=8N1; 1=8N2; 2=8E1 (default); 3=8E2; 4=8O1; 5=8O2. [N=no parity, E=even parity, O=odd parity]	16-bit Integer
2	Instrument address for the MODBUS-RTU protocol (1...247, default=1).	16-bit Integer
3	Heating operating mode: 0= Manual; 1= Always on; 2= Always off; 3= Automatic (default). If the manual mode is set, the heating power set in the next register is used.	16-bit Integer
4	Heating power for the manual operating mode as a percentage of the maximum power (default=50%).	16-bit Integer
5	Precipitation detection threshold as a percentage (x10 if the resolution is 0.1%) of dry sensitive surface of the sensor below which the instrument indicates that a precipitation is in progress (default=97%).	16-bit Integer
6	Hysteresis (x10 if the resolution is 0.1%) of the precipitation detection threshold (0...20%, default=1%).	16-bit Integer

Address	Description	Format
7	Precipitation detection interval (1...30 s, default=1 s).	16-bit Integer
8	Reference temperature, expressed in tenths of the set unit of measurement, to discriminate between rainfall and snowfall (-50...+50=-5.0...+5.0 °C, default=+2.0 °C).	16-bit Integer
9	Hysteresis of the reference temperature, expressed in tenths of the set unit of measurement, to discriminate between rainfall and snowfall (-5...+5=-0.5...+0.5 °C, default=+0.5).	16-bit Integer
10	Delay in indicating the beginning of a precipitation, both rainy and snowy (0...32767 s, default 0). The indication of precipitation in progress is generated only if the precipitation lasts longer than the set time.	16-bit Integer
11	Delay in indicating the end of a precipitation, both rainy and snowy (0...32767 s, default 120 s). The indication of precipitation in progress ceases only after the set time has elapsed from the end of the precipitation.	16-bit Integer
12	Delay in indicating the transition from rainfall to snowfall, when the temperature drops below the reference temperature (0...32767 s, default 0).	16-bit Integer
13	Delay in indicating the transition from snowfall to rainfall, when the temperature rises above the reference temperature plus the hysteresis (0...32767 s, default 0).	16-bit Integer
14	Temperature unit of measurement: 0=°C, 1=°F (default °C).	16-bit Integer
15	Contact output activation mode: 0= Output disabled; 1= Output activated in case of rainfall (default); 2= Output activated in case of snowfall. <i>Note:</i> the precipitation is considered a rainfall if the measured temperature is higher than the reference temperature, and a snowfall if the measured temperature is lower than the reference temperature.	16-bit Integer
16	Resolution with which the percentage of dry sensitive surface of the sensor is detected: 0= 1% (default); 1= 0.1%.	16-bit Integer
17	Enable the precipitation sensor automatic calibration at regular intervals: 0=no, 1=yes (default).	16-bit Integer
18	Time interval between two consecutive precipitation sensor automatic calibrations (300...64800 s, default 1200=20 minutes).	16-bit Integer
19	Maximum correction that can be applied by each precipitation sensor automatic calibration expressed in tenths of % (1...200=0.1...20.0%, default=4).	16-bit Integer
20	Temperature difference (ΔT) that is maintained between the sensor heated base, in the automatic heating operating mode, and the environment expressed in tenths of °C (default 250=25.0 °C). <i>Note:</i> the greater the ΔT , the greater the drying speed of the sensor and the greater the detection of the end of precipitation; on the other hand, the greater the possibility that a very light precipitation is not detected or causes an oscillation in indicating the presence/absence of precipitation. The ΔT setting is therefore a compromise between opposite needs. If the difference ΔT is too low, condensation can form on the sensor surface, which can be detected as precipitation.	16-bit Integer

Address	Description	Format
21	Sensitivity of the precipitation detection (10...1000, default 100). The greater the value, the greater the sensitivity.	16-bit Integer

7 MAINTENANCE

In principle, the precipitation detector is maintenance-free thanks to an adaptive self-correction algorithm. However, it is advisable to carry out a periodical (at least every two years) visual inspection to check for any soiling of the sensitive surface.

If necessary, clean the sensor surface with moistened soft cloth. For more resistant dirt, a non-aggressive detergent or ethyl alcohol can be used.

8 SAFETY INSTRUCTIONS

General safety instructions

The instrument has been manufactured and tested in accordance with the safety standard EN61010-1:2010 "Safety requirements for electrical equipment for measurement, control and laboratory use" and has left the factory in perfect safety technical conditions.

The instrument proper operation and operating safety can be ensured only if all standard safety measures as well as the specific measures described in this manual are followed.

The instrument proper operation and operating safety can be ensured only in the climatic conditions specified in this manual.

Do not use the instruments in places where there are:

- Corrosive or flammable gases.
- Direct vibrations or shocks to the instrument.
- High-intensity electromagnetic fields, static electricity.

User obligations

The instrument operator shall follow the directives and regulations below that refer to the treatment of dangerous materials:

- EEC directives on workplace safety.
- National law regulations on workplace safety.
- Accident prevention regulations.

9 ORDERING CODES

- HD2013.3** Rainfall/snowfall detector. IP68. RS485 output with MODBUS-RTU or proprietary protocol, 0/4...20 mA (0...10 V **on request when ordering**) analog output and voltage-free contact output. Supplied with mounting bracket and 8-pole watertight female free connector. Optional bird spikes (**to be requested when ordering**). **CP2013.2... cable has to be ordered separately.**
- HD2013.2D** Bird spikes (6 spikes \varnothing 3 mm, height 60 mm). **To be requested when ordering the instrument.**
- CP2013.2.5** Cable with 8-pole watertight connector on one end, free wires on the other end. Length 5 m.
- CP2013.2.10** Cable with 8-pole watertight connector on one end, free wires on the other end. Length 10 m.

DELTA OHM metrology laboratories LAT N° 124 are ISO/IEC 17025 accredited by ACCREDIA for Temperature, Humidity, Pressure, Photometry / Radiometry, Acoustics and Air Velocity. They can supply calibration certificates for the accredited quantities.

NOTES

WARRANTY

The manufacturer is required to respond to the "factory warranty" only in those cases provided by Legislative Decree 6 September 2005 - n. 206. Each instrument is sold after rigorous inspections; if any manufacturing defect is found, it is necessary to contact the distributor where the instrument was purchased from. During the warranty period (24 months from the date of invoice) any manufacturing defects found will be repaired free of charge. Misuse, wear, neglect, lack or inefficient maintenance as well as theft and damage during transport are excluded. Warranty does not apply if changes, tampering or unauthorized repairs are made on the product. Solutions, probes, electrodes and microphones are not guaranteed as the improper use, even for a few minutes, may cause irreparable damages.

The manufacturer repairs the products that show defects of construction in accordance with the terms and conditions of warranty included in the manual of the product. For any dispute, the competent court is the Court of Padua. The Italian law and the "Convention on Contracts for the International Sales of Goods" apply.

TECHNICAL INFORMATION

The quality level of our instruments is the result of the continuous product development. This may lead to differences between the information reported in the manual and the instrument you have purchased.

We reserves the right to change technical specifications and dimensions to fit the product requirements without prior notice.

DISPOSAL INFORMATION

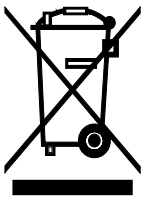

Electrical and electronic equipment marked with specific symbol in compliance with 2012/19/EU Directive must be disposed of separately from household waste. European users can hand them over to the dealer or to the manufacturer when purchasing a new electrical and electronic equipment, or to a WEEE collection point designated by local authorities. Illegal disposal is punished by law.

Disposing of electrical and electronic equipment separately from normal waste helps to preserve natural resources and allows materials to be recycled in an environmentally friendly way without risks to human health.

CE RoHS

